

SMT TP series

Surface mount subminiature washable pushbutton switches



DISTINCTIVE FEATURES

Tape and reel packaging

Reflow solderable

Available with positioning pins

Protected against electrostatic discharges (ESD) up to 10 KV

Washable



ELECTRICAL SPECIFICATIONS

- Max. current/voltage rating with resistive load :
0.4 VA 20 V max. AC or DC
- Minimum load : 10 mA 50 mV or 10 μ A 5 VDC
- Initial contact resistance : 50 m Ω max
- Insulation resistance : 1,000 M Ω min. at 500 VDC
- Dielectric strength :
1,000 Vrms. 50 Hz min. between terminals and frame
500 Vrms. 50 Hz min. between terminals
- Electrical life at full load : 60,000 cycles
- Static resistance : 10 KV (Schaffner equipment)



ENVIRONMENTAL SPECIFICATIONS

- Operating temperature : -40 °C to +85 °C (-40 °F to +185 °F)
- Moisture resistance : 21 days per IEC 512-6 test 11c
- Vibration resistance : 10-500 Hz / 10 g per IEC 512-4 test 6d
- Shock resistance : 50 g per IEC 512-4 test 6c



GENERAL SPECIFICATIONS

- Actuator travel : function 2 : 1 mm (.039) - function 3 : 0.8 mm (.031)
- Distance between case and circuit : 0.55 mm (.021)
- End stackable with 10.16 mm (.40) pitch

The company reserves the right to change specifications without notice.



SMT TP series

Surface mount subminiature washable pushbutton switches



MATERIALS

- Case : high temperature plastic material UL94-V0
- Actuator : high temperature plastic material UL94-V0
- Ground plate and positioning pins : steel, tin plated
- Contacts : brass, gold plated
- Terminals : brass, with pure tin plating over nickel barrier

APEM products may be recycled at end-of-life for the re-claiming of valuable metal components.



SOLDERING AND CLEANING

- Reflow soldering : infrared, vapor phase or infrared convection
- Washable per IEA-RS448-2 :
 - water + detergent - preferred
 - solvents
- Further information on reflow soldering : see "Technical information" on website.



MOUNTING

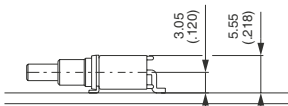

ELECTRICAL FUNCTIONS

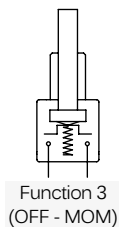
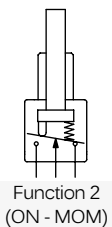

PACKAGING

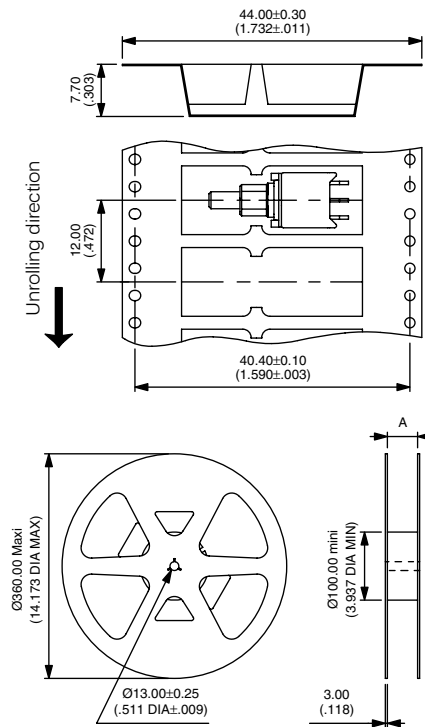

Tape width	24.00 (.944)	44.00 (1.732)
Reel (dimension A)	24.40+2.00/0.00 (.960+.078/.000)	44.40+2.00/0.00 (1.748+.078/.000)

Standard packaging unit : 700 pieces
 Tape meeting international standard IEC -
 Publication 286-3 (EIA481A)
 Start leader : 400 mm min.

SMT TP series

Surface mount subminiature washable pushbutton switches

WITHOUT POSITIONING PINS



TP32WS83500



ON



MOM

TP33WS83500

OFF

MOM

Also available for vertical mounting.

WITH POSITIONING PINS



TP32WS83565



ON



MOM

TP33WS83565

OFF

MOM

Also available for vertical mounting.

SHORT PLUNGER OPTION

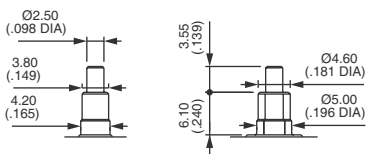

Replace 35 with 30 in the above P/N's.

Shown in function 2

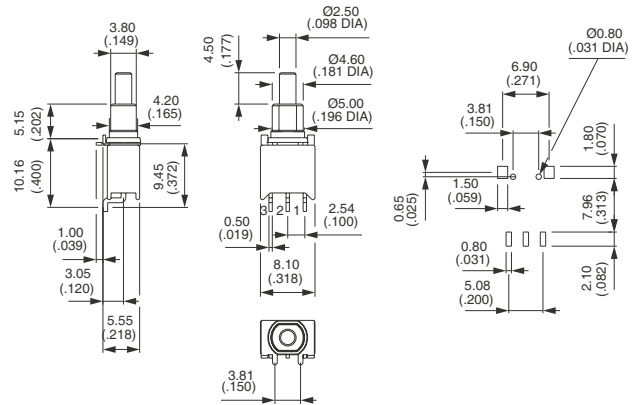
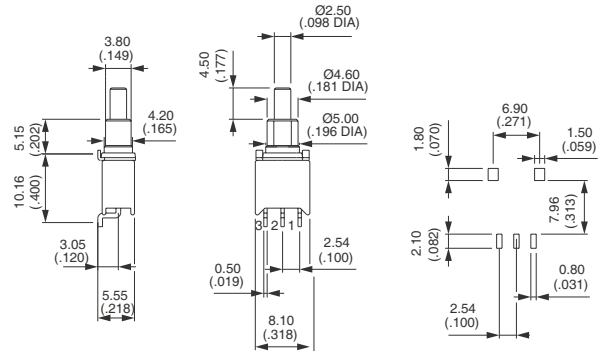

FLUSH PLUNGER OPTION

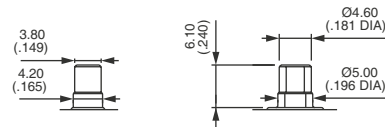

Replace 35 with 32 in the above P/N's.